

Simultaneous Heating&Cooling Output PID Temperature Controllers



TK Series PRODUCT MANUAL

For your safety, read and follow the considerations written in the instruction manual, other manuals and Autonics website.

The specifications, dimensions, etc are subject to change without notice for product improvement. Some models may be discontinued without notice.

Features

- 50ms high-speed sampling rate and $\pm 0.3\%$ display accuracy
- Simultaneous heating and cooling control function (patent) *
- Switch between current output and SSR drive output
- SSR drive output (SSRP function) control options: ON/OFF control, cycle control, phase control
- Communication output models available: RS485 (Modbus RTU)
- Parameter configuration via PC (RS485 communication)
 - DAQMaster software included (comprehensive device management software)
 - Communication converter sold separately: SCM-US (USB to serial converter), SCM-381 (RS-232C to RS485 converter), SCM-US481 (USB to RS485 converter)
- User-friendly parameter features
- Heater disconnect alarm function (CT input)
 - Current transformer (CT) sold separately: CSTC-E80LN, CSTC-E200LN, CSTS-E80PP
- SV preset function (up to 4 set values) using digital input terminals
- Available in various DIN sizes: (48×24, 48×48, 72×72, 96×48, 48×96, 96×96 mm)

*Korea Patent Registration 10-1002582, U.S.A. Patent Registration 8645000, Japan Patent Registration 3184816, China Patent Registration ZL200980111733.X, Vietnam Patent Registration 1-0012131, India Patent Registration 291573, Indonesia Patent Registration IDP0032166

Safety Considerations

- Observe all 'Safety Considerations' for safe and proper operation to avoid hazards.
-  symbol indicates caution due to special circumstances in which hazards may occur.

Warning Failure to follow instructions may result in serious injury or death

- 01. Fail-safe device must be installed when using the unit with machinery that may cause serious injury or substantial economic loss.** (e.g. nuclear power control, medical equipment, ships, vehicles, railways, aircraft, combustion apparatus, safety equipment, crime/disaster prevention devices, etc.)
Failure to follow this instruction may result in personal injury, economic loss or fire.
- 02. Do not use the unit in the place where flammable/explosive/corrosive gas, high humidity, direct sunlight, radiant heat, vibration, impact or salinity may be present.**
Failure to follow this instruction may result in explosion or fire.
- 03. Install on a device panel to use.**
Failure to follow this instruction may result in electric shock.
- 04. Do not connect, repair, or inspect the unit while connected to a power source.**
Failure to follow this instruction may result in fire or electric shock.
- 05. Check 'Connections' before wiring.**
Failure to follow this instruction may result in fire.
- 06. Do not disassemble or modify the unit.**
Failure to follow this instruction may result in fire or electric shock.

Caution Failure to follow instructions may result in injury or product damage

- 01. When connecting the power input and relay output, use AWG 20 (0.50 mm²) cable or over, and tighten the terminal screw with a tightening torque of 0.74 to 0.90 N m.**
When connecting the sensor input and communication cable without dedicated cable, use AWG 28 to 16 cable and tighten the terminal screw with a tightening torque of 0.74 to 0.90 N m.
Failure to follow this instruction may result in fire or malfunction due to contact failure.
- 02. Use the unit within the rated specifications.**
Failure to follow this instruction may result in fire or product damage.
- 03. Use a dry cloth to clean the unit, and do not use water or organic solvent.**
Failure to follow this instruction may result in fire or electric shock.
- 04. Keep the product away from metal chip, dust, and wire residue which flow into the unit.**
Failure to follow this instruction may result in fire or product damage.

Cautions during Use

- Follow instructions in 'Cautions during Use'. Otherwise, it may cause unexpected accidents.
- Check the polarity of the terminals before wiring the temperature sensor. For RTD temperature sensor, wire it as 3-wire type, using cables in same thickness and length. For thermocouple (TC) temperature sensor, use the designated compensation wire for extending wire.
- Keep away from high voltage lines or power lines to prevent inductive noise. In case installing power line and input signal line closely, use line filter or varistor at power line and shielded wire at input signal line. Do not use near the equipment which generates strong magnetic force or high frequency noise.
- Do not apply excessive power when connecting or disconnecting the connectors of the product.
- Install a power switch or circuit breaker in the easily accessible place for supplying or disconnecting the power.
- Do not use the unit for other purpose (e.g. voltmeter, ammeter), but temperature controller.
- When changing the input sensor, turn off the power first before changing. After changing the input sensor, modify the value of the corresponding parameter.

- 24 VAC~, 24-48 VDC= power supply should be insulated and limited voltage/current or Class 2, SELV power supply device.
- Do not overlapping communication line and power line. Use twisted pair wire for communication line and connect ferrite bead at each end of line to reduce the effect of external noise.
- Make a required space around the unit for radiation of heat. For accurate temperature measurement, warm up the unit over 20 min after turning on the power.
- Make sure that power supply voltage reaches to the rated voltage within 2 sec after supplying power.
- Do not wire to terminals which are not used.
- This unit may be used in the following environments.
 - Indoors (in the environment condition rated in 'Specifications')
 - Altitude Max. 2,000 m
 - Pollution degree 2
 - Installation category II

Ordering Information

This is only for reference, the actual product does not support all combinations. For selecting the specified model, follow the Autonics website .

T K ① ② - ③ ④ ⑤ ⑥

① Digit

4: 4 digit

② Size

N: DIN W 48 × H 24 mm

SP: DIN W 48 × H 48 mm (11 pin plug type)

S: DIN W 48 × H 48 mm

M: DIN W 72 × H 72 mm

W: DIN W 96 × H 48 mm

H: DIN W 48 × H 96 mm

L: DIN W 96 × H 96 mm

③ Option in/output

Size: N	PN	OUT2	Function
1	1	Normal type ⁽⁰¹⁾	Alarm 1 + CT input
		Heating & Cooling	Alarm 2
2	2	Normal type	Alarm 1 + Alarm 2
		Heating & Cooling	Digital input 1/2
D	D	Normal type	Alarm 1 + Digital input 1/2
		Heating & Cooling	Digital input 1/2
R	R	Normal type	Alarm 1+Transmission output
		Heating & Cooling	Transmission output
T	T	Normal type	Alarm output 1 + RS485 communication
		Heating & Cooling	RS485 communication

Size: SP	PN	Function
1	1	Alarm 1

Size: S, M, W, H, L	PN	Function
1	1	Alarm 1
2	2	Alarm 1 + Alarm output 2
R	R	Alarm 1 + Transmission output
T	T	Alarm 1 + RS485 communication
A	A	Alarm 1 + Alarm 2 + Transmission output
B	B	Alarm 1 + Alarm 2 + RS485 communication
D	D	Alarm 1 + Alarm 2 + Digital input 1/2 ⁽⁰²⁾

01) The CT input model of TK4N can be selected only in the normal type model with alarm output 1. (except TK4SP)

02) Only for TK4S-D, OUT2 output terminal is used as DI-2 input terminal.

03) When operating mode is heating or cooling control, OUT2 can be used as alarm output 3 (except TK4N).

04) When operating mode is heating or cooling control, OUT2 can be used as transmission output 2.

Product Components

- Product (+ bracket)
- Instruction manual
- [TK4N] Terminal protection cover × 1

Manual

For proper use of the product, refer to the manuals and be sure to follow the safety considerations in the manuals. Download the manuals from the Autonics website.

Software

Download the installation file and the manuals from the Autonics website.

■ DAQMaster

DAQMaster is comprehensive device management program. It is available for parameter setting, monitoring.





Sold Separately

- Current transformer (CT)
- 11-pin controller socket: PG-11, PS-11 (N)
- Terminal protection cover: RSA / RMA / RHA / RLA-Cover
- Communication Converter: SCM-US / SCM-38I / SCM-US48I / SCM-WF48

Specifications

Series	TK4N	TK4SP	TK4S	TK4M
Power supply	AC type	100 - 240 VAC~ 50/60 Hz		
	AC/DC type	-	24 VAC~ 50/60 Hz, 24-48 VDC=	
Permissible voltage range		90 to 110 % of rated voltage		
Power consumption	AC type	≤ 6 VA	≤ 8 VA	
	AC/DC type	-	AC: ≤ 8 VA, DC: ≤ 5W	
Unit weight (packaged)		≈ 70 g (≈ 140 g)	≈ 85 g (≈ 130 g)	≈ 105 g (≈ 150 g)
				≈ 140 g (≈ 210 g)

Series	TK4W	TK4H	TK4L	
Power supply	AC type	100 - 240 VAC~ 50/60 Hz		
	AC/DC type	24 VAC~ 50/60 Hz, 24-48 VDC=		
Permissible voltage range		90 to 110 % of rated voltage		
Power consumption	AC type	≤ 8 VA		
	AC/DC type	AC: ≤ 8 VA, DC: ≤ 5W		
Unit weight (packaged)		≈ 141 g (≈ 211 g)	≈ 141 g (≈ 211 g)	≈ 198 g (≈ 294 g)

Sampling period		50 ms
Input specification		Refer to 'Input Type and Using Range'
Option input	CT input	<ul style="list-style-type: none"> • 0.0-50.0 A (primary current measurement range) • CT ratio: 1/1,000 • Measurement accuracy: ±5% F.S. ±1digit
	Digital input	<ul style="list-style-type: none"> • Contact - ON: ≤ 2 kΩ, OFF: ≥ 90 kΩ • Non contact - residual voltage ≤ 1.0 V, leakage current ≤ 0.1 mA • Outflow current: ≈ 0.5 mA per input
Control output	Relay	250 VAC~ 3 A, 30 VDC= 3 A 1a
	SSR	11 VDC= ±2 V, ≤ 20 mA
Alarm output	Current	DC 4-20 mA or DC 0-20 mA (parameter), Load resistance: ≤ 500 Ω
Option output	Relay	AL1, AL2: 250 VAC~ 3 A 1a • TK4N AL2: 250 VAC~ 0.5 A 1a (≤ 125 VA)
	Transmission	DC 4 - 20 mA (Load resistance: ≤ 500 Ω, Output accuracy: ±0.3% F.S.)
	RS485 comm.	Modbus RTU
Display type		7 segment (red, green, yellow), LED type
Control type	Heating, Cooling	ON/OFF, P, PI, PD, PID Control
	Heating & Cooling	
Hysteresis		<ul style="list-style-type: none"> • Thermocouple, RTD: 1 to 100 (0.1 to 100.0) °C/°F • Analog: 1 to 100 digit
Proportional band (P)		0.1 to 999.9 °C/°F (0.1 to 999.9%)
Integral time (I)		0 to 9,999 sec
Derivative time (D)		0 to 9,999 sec
Control cycle (T)		<ul style="list-style-type: none"> • Relay output, SSR drive output: 0.1 to 120.0 sec • Selectable current or SSR drive output: 1.0 to 120.0 sec
Manual reset		0.0 to 100.0%
Relay life cycle	Mechanical	OUT1/2: ≥ 5,000,000 operations AL1/2: ≥ 20,000,000 operations (TK4H/W/L: ≥ 5,000,000 operations)
	Electrical	≥ 100,000 operations
Dielectric strength		Dependent on the power supply
AC voltage type		Between the charging part and the case: 3,000 VAC ~ 50/60 Hz for 1 minute
AC / DC voltage type		Between the charging part and the case: 2,000 VAC ~ 50/60 Hz for 1 minute
Vibration		0.75 mm amplitude at frequency of 5 to 55 Hz in each X, Y, Z direction for 2 hours
Insulation resistance		≥ 100 MΩ (500 VDC= megger)
Noise immunity		±2 kV square shaped noise by noise simulator (pulse width: 1 μs) R-phase, S-phase
Memory retention		≈ 10 years (non-volatile semiconductor memory type)
Ambient temperature		-10 to 50 °C, storage: -20 to 60 °C (no freezing or condensation)
Ambient humidity		35 to 85%RH, storage: 35 to 85%RH (no freezing or condensation)
Protection structure		IP65 (Front panel, IEC standards) • TK4SP: IP50 (Front panel, IEC standards)
Insulation type		Double insulation or reinforced insulation (mark:  , dielectric strength between the measuring input part and the power part: 2 kV)
Certification		CE   

Communication Interface

■ RS485

Comm. protocol	Modbus RTU
Connection type	RS485
Application standard	EIA RS485 compliance with
Maximum connection	31 units (address: 01 to 99)
Synchronous method	Asynchronous
Comm. Method	Two-wire half duplex
Comm. effective range	≤ 800 m
Comm. speed	2,400 / 4,800 / 9,600 (default) / 19,200 / 38,400 bps (parameter)
Response time	5 to 99 ms (default: 20 ms)
Start bit	1 bit (fixed)
Data bit	8 bit (fixed)
Parity bit	None (default), Odd, Even
Stop bit	1 bit, 2 bit (default)
EEPROM life cycle	≈ 1,000,000 operations (Erase / Write)

Input Type and Using Range

The setting range of some parameters is limited when using the decimal point display.

Input type	Decimal point	Display	Using range (°C)	Using range (°F)	
Thermo-couple	K (CA)	1	ℰℰRH	-200 to 1,350	-328 to 2,462
		0.1	ℰℰRL	-199.9 to 999.9	-199.9 to 999.9
	J (IC)	1	ℰℰRH	-200 to 800	-328 to 1,472
		0.1	ℰℰL	-199.9 to 800.0	-199.9 to 999.9
	E (CR)	1	ℰℰr.H	-200 to 800	-328 to 1,472
		0.1	ℰℰr.L	-199.9 to 800.0	-199.9 to 999.9
	T (CC)	1	ℰℰℰ.H	-200 to 400	-328 to 752
		0.1	ℰℰℰ.L	-199.9 to 400.0	-199.9 to 752.0
	B (PR)	1	b P r	0 to 1,800	32 to 3,272
	R (PR)	1	r P r	0 to 1,750	32 to 3,182
	S (PR)	1	s P r	0 to 1,750	32 to 3,182
	N (NN)	1	n n n	-200 to 1,300	-328 to 2,372
C (TT) ⁰¹⁾	1	ℰ ℰ ℰ	0 to 2,300	32 to 4,172	
G (TT) ⁰²⁾	1	ℰ ℰ ℰ	0 to 2,300	32 to 4,172	
RTD	L (IC)	1	ℰ ℰ ℰ.H	-200 to 900	-328 to 1,652
		0.1	ℰ ℰ ℰ.L	-199.9 to 900.0	-199.9 to 999.9
	U (CC)	1	ℰ ℰ ℰ.H	-200 to 400	-328 to 752
		0.1	ℰ ℰ ℰ.L	-199.9 to 400.0	-199.9 to 752.0
	Platinel II	1	P L I I	0 to 1,390	32 to 2,534
	Cu50 Ω	0.1	ℰ U 5	-199.9 to 200.0	-199.9 to 392.0
	Cu100 Ω	0.1	ℰ U 10	-199.9 to 200.0	-199.9 to 392.0
	JPt100 Ω	1	ℰ P ℰ.H	-200 to 650	-328 to 1,202
		0.1	ℰ P ℰ.L	-199.9 to 650.0	-199.9 to 999.9
	DPT50 Ω	0.1	ℰ P ℰ 5	-199.9 to 600.0	-199.9 to 999.9
	DPT100 Ω	1	ℰ P ℰ.H	-200 to 650	-328 to 1,202
	0.1	ℰ P ℰ.L	-199.9 to 650.0	-199.9 to 999.9	
Nickel120 Ω	1	n i 12	-80 to 200	-112 to 392	
Analog	0 to 10V	-	R u 1	0 to 10V	
	0 to 5V	-	R u 2	0 to 5V	
	1 to 5V	-	R u 3	1 to 5V	
	0 to 100 mV	-	R n 1	0 to 100 mV	
	0 to 20 mA	-	R n R 1	0 to 20 mA	
	4 to 20 mA	-	R n R 2	4 to 20 mA	

01) C (TT): Same as existing W5 (TT) type sensor

02) G (TT): Same as existing W (TT) type sensor

• Permissible line resistance per line: ≤ 5 Ω

Display accuracy

Input type	Using temperature	Display accuracy
Thermo-couple RTD	At room temperature (23°C ± 5°C)	(PV ± 0.3% or ± 1°C higher one) ± 1-digit • Thermocouple K, J, T, N, E below -100°C and L, U, PLII, RTD Cu50 Ω, DPT50 Ω: (PV ± 0.3% or ± 2°C higher one) ± 1-digit • Thermocouple C, G and R, S below 200°C: (PV ± 0.3% or ± 3°C higher one) ± 1-digit • Thermocouple B below 400°C: There is no accuracy standards
	Out of room temperature range	(PV ± 0.5% or ± 2°C higher one) ± 1-digit • RTD Cu50 Ω, DPT50 Ω: (PV ± 0.5% or ± 3°C higher one) ± 1-digit • Thermocouple R, S, B, C, G: (PV ± 0.5% or ± 5°C higher one) ± 1-digit • Other sensors: ≤ ± 5°C (≤ -100°C)
Analog	At room temperature (23°C ± 5°C)	± 0.3% F.S. ± 1-digit
	Out of room temperature range	± 0.5% F.S. ± 1-digit

• In case of TK4SP Series, ± 1°C will be added to the degree standard.

Unit Descriptions



- PV display part (Red)**
 - Run mode: Displays PV (Present value).
 - Setting mode: Displays parameter name.
- SV display part (Green)**
 - Run mode: Displays SV (Setting value).
 - Setting mode: Displays parameter setting value.
- Input key**

Display	Name
[A/M]	Control switching key
[MODE]	Mode key
[◀], [▼], [▲]	Setting value control key

4. Indicator

Display	Name	Description
°C, %, °F	Unit	Displays selected unit (parameter)
AT	Auto tuning	Flashes during auto tuning every 1 sec
OUT1/2	Control output	Turns ON when the control output is ON • SSR output (cycle/phase control) MV over 5% ON • Current output Manual control: 0% OFF, over ON Auto control: below 2% OFF, over 3% ON
AL1/2	Alarm output	Turns ON when the alarm output is ON
MAN	Manual control	Turns ON during manual control
SV1/2/3	Multi SV	The SV indicator is ON which is currently displayed. (When using multi SV function)



5. PC loader port:
For connecting communication converter (SCM series).

• For the details about old model, refer to the user manual. Download the manuals from the Autonics website.

Dimensions

- Unit: mm, For the detailed drawings, follow the Autonics website.
- Below is based on TK4S Series.

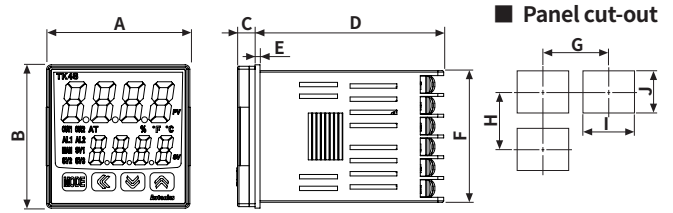

	Body						Panel cut-out			
	A	B	C	D	E	F	G	H	I	J
TK4N	48	24	3	91.8	-	21.8	≥ 55	≥ 37	45 ^{+0.6} ₀	22.2 ^{+0.3} ₀
TK4S	48	48	6	64.5	1.7	45	≥ 65	≥ 65	45 ^{+0.6} ₀	45 ^{+0.6} ₀
TK4SP	48	48	6	72.2	-	44.8	≥ 65	≥ 65	45 ^{+0.6} ₀	45 ^{+0.6} ₀
TK4M	72	72	6	64.5	1.7	67.5	≥ 90	≥ 90	68 ^{+0.7} ₀	68 ^{+0.7} ₀
TK4W	96	48	6	64.5	1.5	44.7	≥ 115	≥ 65	92 ^{+0.6} ₀	45 ^{+0.6} ₀
TK4H	48	96	6	64.5	1.5	91.5	≥ 65	≥ 115	45 ^{+0.6} ₀	92 ^{+0.6} ₀
TK4L	96	96	6	64.5	1.5	91.5	≥ 115	≥ 115	92 ^{+0.6} ₀	92 ^{+0.6} ₀

Bracket

TK4N

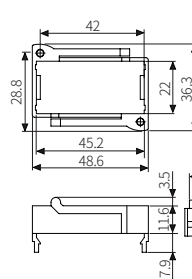

TK4S/SP

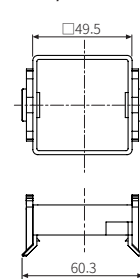

Other series

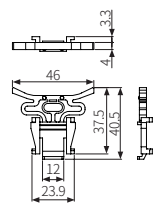

Terminal protection cover

TK4N

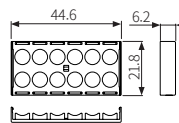

Installation Method

TK4N

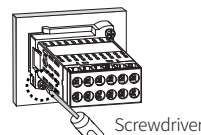

After mounting the product to panel with bracket, fasten the bolts by using screwdriver.

Other series

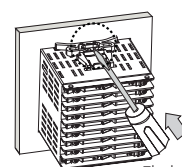

Insert the unit into a panel, fasten the bracket by pushing with a flathead screwdriver.

Errors

Display	Input	Description	Output	Troubleshooting
o P E n	Temperature sensor	Flashes at 0.5 sec interval when input sensor is disconnected or sensor is not connected.	'Sensor error, MV' parameter setting value	Check input sensor status.
	Analog	Flashes at 0.5 sec interval when input is over F.S. ± 10%.	'Sensor error, MV' parameter setting value	Check analog input status.
H H H H	Temperature sensor	Flashes at 0.5 sec intervals if the input value is above the input range. ⁰¹⁾	Heating: 0%, Cooling: 100%	When input is within the rated input range, this display disappears.
	Analog	Flashes at 0.5 sec intervals if the input value is over 5 to 10% of high limit or low limit value.	Normal output	
L L L L	Temperature sensor	Flashes at 0.5 sec. intervals if the input value is below the input range. ⁰¹⁾	Heating: 100%, Cooling: 0%	When input is within the rated input range, this display disappears.
	Analog	Flashes at 0.5 sec intervals if the input value is over 5 to 10% of low limit or high limit value.	Normal output	
E r r	Temperature sensor	Flashes at 0.5 sec intervals if there is error for setting and it returns to the error-before screen.	-	Check setting method.
	Analog	Flashes at 0.5 sec intervals if there is error for setting and it returns to the error-before screen.	-	Check setting method.

01) Be careful that when H H H H / L L L L error occurs, the control output may occur by recognizing the maximum or minimum input depending on the control type.

Connections

- Shaded terminals are standard model.
- Digital input is not electrically insulated from internal circuits, so it should be insulated when connecting other circuits.

TK4N

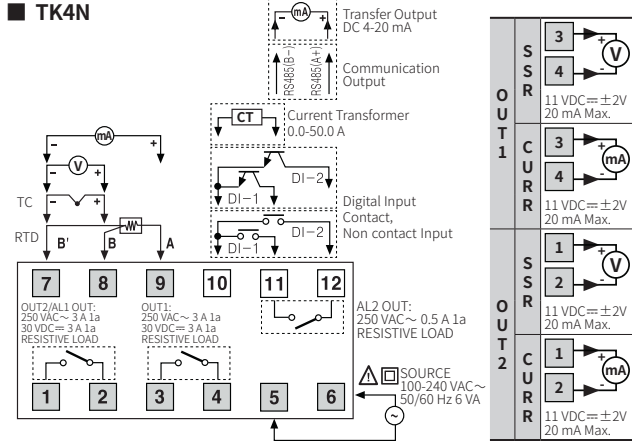

TK4S

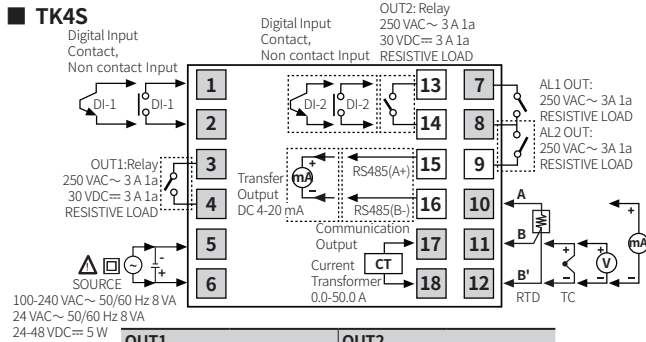

OUT1		OUT2	
SSR	Current	SSR	Current
11 VDC \pm 2V 20 mA Max.	DC 0/4-20 mA Load 500 Ω Max.	11 VDC \pm 2V 20 mA Max.	DC 0/4-20 mA Load 500 Ω Max.

TK4SP

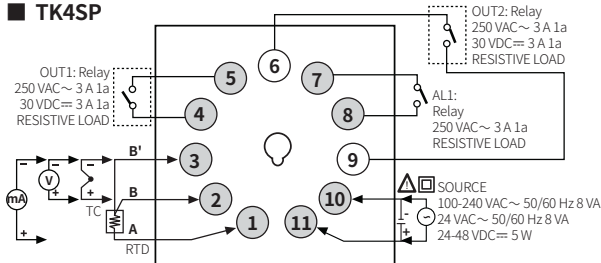

OUT1		OUT2	
SSR	Current	SSR	Current
11 VDC \pm 2V 20 mA Max.	DC 0/4-20 mA Load 500 Ω Max.	11 VDC \pm 2V 20 mA Max.	DC 0/4-20 mA Load 500 Ω Max.

TK4M

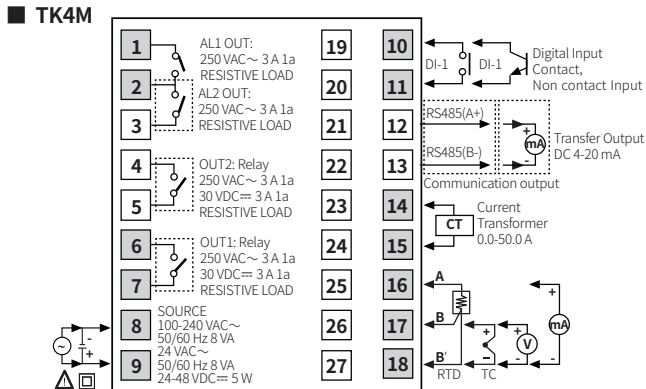

OUT1		OUT2	
SSR	Current	SSR	Current
11 VDC \pm 2V 20 mA Max.	DC 0/4-20 mA Load 500 Ω Max.	11 VDC \pm 2V 20 mA Max.	DC 0/4-20 mA Load 500 Ω Max.

TK4H / W / L

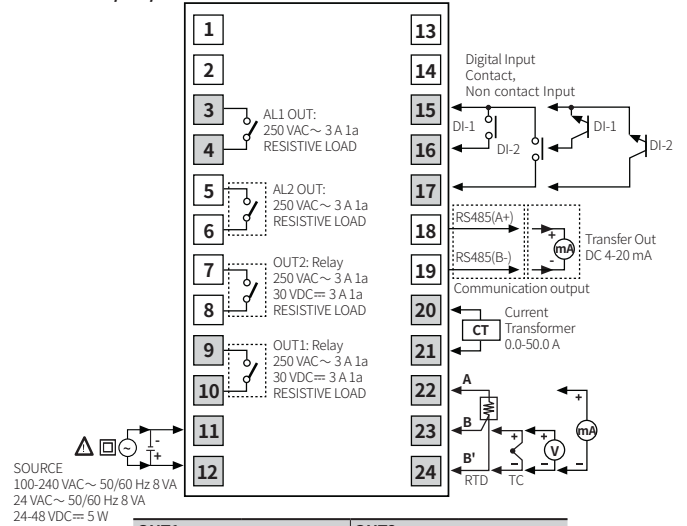

OUT1		OUT2	
SSR	Current	SSR	Current
11 VDC \pm 2V 20 mA Max.	DC 0/4-20 mA Load 500 Ω Max.	11 VDC \pm 2V 20 mA Max.	DC 0/4-20 mA Load 500 Ω Max.

Crimp Terminal Specifications

- Unit: mm, Use the crimp terminal of follow shape.

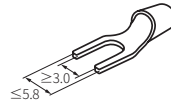

Fork crimp terminal

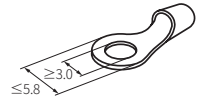

Round crimp terminal

Initial Display When Power is ON

When power is supplied, after all display will flash for 1 sec, model name is displayed sequentially. After input sensor type will flash twice, enter into RUN mode.

	1. All display	2. Model	3. Input specification	4. Run mode
PV display part	8.8.8.8	tttY	tttY	oPEn
SV display part	8.8.8.8	14rn	tttR.H	0

Mode Setting

	Auto before entering to mode (when using password)	Password input	Password	Key input	Entering mode
		Pass	Auto		Selected mode
		Fail	[◀], [▶], [▼]		Password input
			[MODE]		Run mode
	[◀], [▶], [▼]			Move digits: [◀] Save: [MODE]	or no key input over 5 sec
	[MODE] over 2 sec			Parameter group	
	[◀] + [▶] + [▼] over 5 sec			Parameter reset	Auto
	[A/M] ⁰¹⁾			Auto/Manual control switching	[A/M]
	[▶] + [▼] over 3 sec			Digital input key	Auto

01) In case of TK4N / 4S / 4SP model, short press of [MODE] key replaces [A/M] key function.

Parameter Setting

- Some parameters are activated/deactivated depending on the model or setting of other parameters.
- The 'Parameter mask' feature, which hide unnecessary or inactive parameters, and the 'User parameter group' feature, which quickly and easily set up certain parameters that are frequently used, can be set up in DAQMaster.
- Refer to the user manual for the details.

Parameter 1 group

Parameter	Display	Default
Control output RUN/STOP	r - s	r Un
Multi SV selection	5 u - n	5 u - 0
Heater current monitoring	C t - A	0 0
Alarm output1 low limit	AL L L	15 5 0
Alarm output1 high limit	AL L H	15 5 0
Alarm output2 low limit	AL 2 L	15 5 0
Alarm output2 high limit	AL 2 H	15 5 0
Alarm output3 low limit	AL 3 L	15 5 0
Alarm output3 high limit	AL 3 H	15 5 0
Multi SV 0	5 u - 0	0 0 0 0
Multi SV 1	5 u - 1	0 0 0 0
Multi SV 2	5 u - 2	0 0 0 0
Multi SV 3	5 u - 3	0 0 0 0

Parameter 2 group

Parameter	Display	Default
Auto tuning RUN/STOP	At	o F F
Heating proportional band	H - P	0 1 0 0
Cooling proportional band	C - P	0 1 0 0
Heating integral time	H - I	0 0 0 0
Cooling integral time	C - I	0 0 0 0
Heating derivative time	H - d	0 0 0 0
Cooling derivative time	C - d	0 0 0 0
Dead overlap band	db	0 0 0 0
Manual reset	r E S t	0 5 0 0
Heating hysteresis	H H Y S	0 0 2
Heating OFF offset	H o S t	0 0 0
Cooling hysteresis	C H Y S	0 0 2
Cooling OFF offset	C o S t	0 0 0
MV low limit	L - n u	- 1 0 0 0
MV high limit	H - n u	1 0 0 0
RAMP up change rate	r R n U	0 0 0
RAMP down change rate	r R n d	0 0 0
RAMP time unit	r U n t	n 1 n

Parameter 3 group

Parameter	Display	Default
Input specification	i n - t	2 C R H
Temperature unit	U n i t	° C
Analog low limit	L - r G	0 0 0 0
Analog high limit	H - r G	1 0 0 0
Scaling decimal point	d o t	0 0
Low limit scale	L - S C	0 0 0 0
High limit scale	H - S C	1 0 0 0
Display unit	d U n t	° P o
Input correction	i n - b	0 0 0 0
Input digital filter	ñ R u F	0 0 0 1
SV low limit	L - S u	- 2 0 0
SV high limit	H - S u	1 3 5 0

Parameter	Display	Default
Control output mode	o - F t	H E R t (Normal type) H - C (Heating & Cooling type)
Control type	C - n d	P I d (Normal type) P P (Heating & Cooling type)
Auto tuning mode	At t	t U n i
OUT1 control output selection	o U t 1	C U r r
OUT1 SSR drive output type	o I S r	5 t n d
OUT1 current output range	o I n R	4 - 2 0
OUT2 control output selection	o U t 2	C U r r
OUT2 current output range	o 2 n R	4 - 2 0
Heating control cycle	H - t	0 2 0 0 (Relay)
Cooling control cycle	C - t	0 0 2 0 (SSR)

Parameter 4 group

Parameter	Display	Default
Alarm output1 Operation mode	AL - 1	d u C C
Alarm output1 Option	AL L t	AL - A
Alarm output1 Hysteresis	A L H Y	0 0 1
Alarm output1 contact type	A l n	n o
Alarm output1 ON delay time	A l o n	0 0 0 0
Alarm output1 OFF delay time	A l o F	0 0 0 0
Alarm output2 Operation mode	AL - 2	C J d u
Alarm output2 Option	AL 2 t	AL - A
Alarm output2 Hysteresis	A 2 H Y	0 0 1
Alarm output2 contact type	A 2 n	n o
Alarm output2 ON delay time	A 2 o n	0 0 0 0
Alarm output2 OFF delay time	A 2 o F	0 0 0 0
Alarm output3 Operation mode	AL - 3	o F F
Alarm output3 Option	AL 3 t	AL - A
Alarm output3 Hysteresis	A 3 H Y	0 0 1
Alarm output3 contact type	A 3 n	n o
Alarm output3 ON delay time	A 3 o n	0 0 0 0
Alarm output3 OFF delay time	A 3 o F	0 0 0 0
LBA time	L b A t	0 0 0 0
LBA band	L b A b	0 0 2 (0 0 3)
Analog Transmission output1 Mode	A o n 1	P u
Transmission output1 low limit	F S L 1	- 2 0 0
Transmission output1 high limit	F S H 1	1 3 5 0
Analog Transmission output2 Mode	A o n 2	P u
Transmission output2 low limit	F S L 2	- 2 0 0
Transmission output2 high limit	F S H 2	1 3 5 0
Communication address	A d r S	0 1
Communication speed	b P S	9 6
Comm. parity bit	P r e Y	n o n E
Comm. stop bit	S t P	2
Response time	r S t	2 0
Comm. write	C o n Y	E n A

Parameter 5 group

Parameter	Display	Default
Multi SV number	n t. S u	1
Digital input key	d i - t	5 t o P
Digital input1 Terminal Function	d i - 1	o F F
Digital input2 Terminal Function	d i - 2	o F F
Manual control, initial MV	I t. n u	A U t o
Manual control, preset MV	P r. n u	0 0 0 0
Sensor error MV	E r. n u	0 0 0 0
Control stop MV	S t. n u	0 0 0 0
Control stop alarm output	S t. A L	C o n t
User level	U S E r	5 t n d
SV setting lock	L C. S u	o F F
Parameter 1 group lock	L C. P 1	o F F
Parameter 2 group lock	L C. P 2	o F F
Parameter 3 group lock	L C. P 3	o F F
Parameter 4 group lock	L C. P 4	o F F
Parameter 5 group lock	L C. P 5	o F F
Password setting	P y d	0 0 0 0

Function: Alarm

000.0

Alarm operation Alarm option

Set both alarm operation and alarm option by combining. Each alarm operates individually in two alarm output models. When the current temperature is out of alarm range, alarm clears automatically.

Operation

• H: Alarm output hysteresis

Name	Alarm operation	Description
-	-	No alarm output
Deviation high limit		If deviation between PV and SV as high-limit is higher than set value of deviation temperature, the alarm output will be ON. High deviation: Set as 10°C
Deviation low limit		If deviation between PV and SV as low limit is higher than set value of deviation temperature, the alarm output will be ON. Low deviation: Set as 10°C
Deviation high, low limit		If deviation between PV and SV as high/low-limit is higher than set value of deviation temperature, the alarm output will be ON. High, Low deviation: Set as 10°C
Deviation high, low limit reverse		If deviation between PV and SV as high/low-limit is lower than set value of deviation temperature, the alarm output will be OFF. High, Low deviation: Set as 10°C
Absolute value high limit		If PV is higher than the absolute value, the output will be ON. Absolute value: Set as 90°C
Absolute value low limit		If PV is lower than the absolute value, the output will be ON. Absolute value: Set as 90°C
Sensor break	-	It will be ON when it detects sensor disconnection.
Heater break	-	It will be ON when it detects heater disconnection.
Loop break	-	It will be ON when it detects loop disconnection.

Option

Name	Description	Condition of re-apply
Standard alarm	If it is an alarm condition, alarm output is ON. If it is a clear alarm condition, alarm output is OFF.	-
Alarm latch	If it is an alarm condition, alarm output is ON and maintains ON status.	-
Standby sequence 1	First alarm condition is ignored and from second alarm condition, standard alarm operates. When power is supplied and it is an alarm condition, this first alarm condition is ignored and from the second alarm condition, standard alarm operates.	Power ON
Alarm latch and standby sequence 1	If it is an alarm condition, it operates both alarm latch and standby sequence. When power is supplied and it is an alarm condition, this first alarm condition is ignored and from the second alarm condition, alarm latch operates.	Power ON
Standby sequence 2	First alarm condition is ignored and from second alarm condition, standard alarm operates. When re-applied standby sequence and if it is alarm condition, alarm output does not turn ON. After clearing alarm condition, standard alarm operates.	Power ON, change SV, change alarm temperature / operation or change STOP to RUN mode
Alarm latch and standby sequence 2	Basic operation is same as alarm latch and standby sequence1. It operates not only by power ON/OFF, but also alarm set value, or alarm option changing. When re-applied standby sequence and if it is alarm condition, alarm output does not turn ON. After clearing alarm condition, alarm latch operates.	Power ON, change SV, change alarm temperature / operation or change STOP to RUN mode

Sold Separately: Current Transformer (CT)

- Unit: mm
- The current for above CTs is 50A same but inner hole sizes are different. Please use this for your environment.
- Do not supply primary current in case that CT output is open. High voltage will be generated in CT output.

CSTC-E80LN

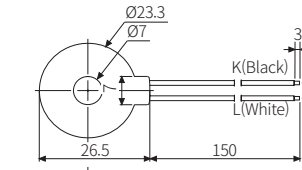

- Max. load current: 80A (50/60Hz)
- Current ratio: 1/1000
- Wire wounded resistance: $31\Omega \pm 10\%$

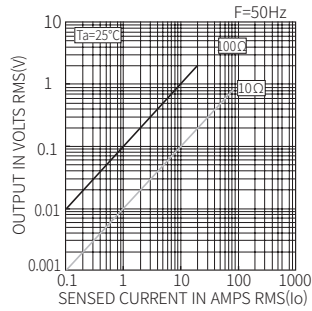

CSTC-E200LN

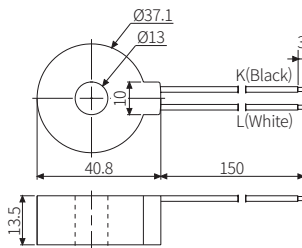

- Max. load current: 200A (50/60Hz)
- Current ratio: 1/1000
- Wire wounded resistance: $20\Omega \pm 10\%$

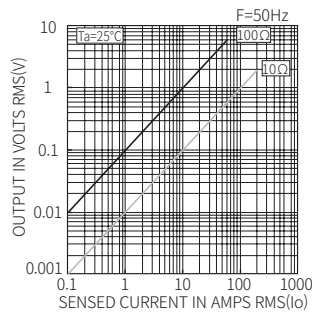

CSTS-E80PP

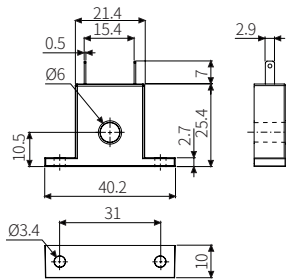

- Max. load current: 80A (50/60Hz)
- Current ratio: 1/1000
- Wire wounded resistance $31\Omega \pm 10\%$

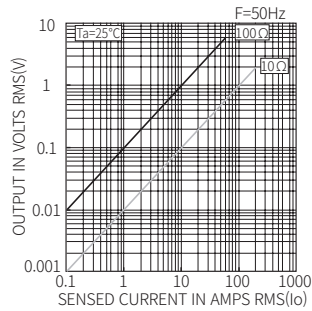

Sold Separately: 11-pin Controller Socket

- For detailed information, refer to the 'PG Series, PS Series' manual.

Appearance	Pins	Rated Voltage	Rated current	Feature	Model
	11-pin	250 VAC~	7 A (resistance load)	Controller socket	PG-11
	11-pin	250 VAC~	7 A (resistance load)	Controller socket (DIN Rail / Panel)	PS-11(N)

Sold Separately: Terminal Protection Cover

- Unit: mm

RSA-COVER: DIN W48 × H48

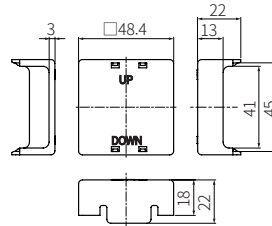

RMA-COVER: DIN W72 × H72

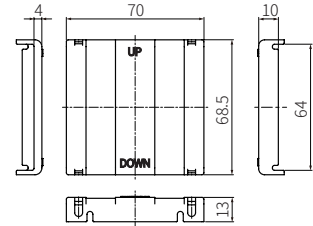

RHA-COVER: DIN W48 × H96

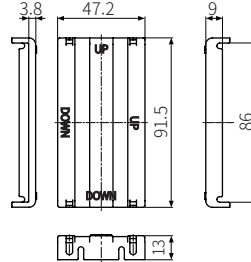

RLA-COVER: DIN W96 × H96

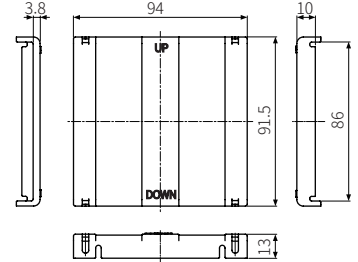

Segment Table

The segments displayed on the product indicate the following meanings. It may differ depending on the product.

7 segment	11 segment	12 segment	16 segment
0	0	0	0
1	1	1	1
2	2	2	2
3	3	3	3
4	4	4	4
5	5	5	5
6	6	6	6
7	7	7	7
8	8	8	8
9	9	9	9
A	A	A	A
b	b	b	b
c	c	c	c
d	d	d	d
E	E	E	E
F	F	F	F
G	G	G	G
H	H	H	H